

DC/AC Micro Control Power Inverter/Charger

(for power supply back-up system – UPS with big power)

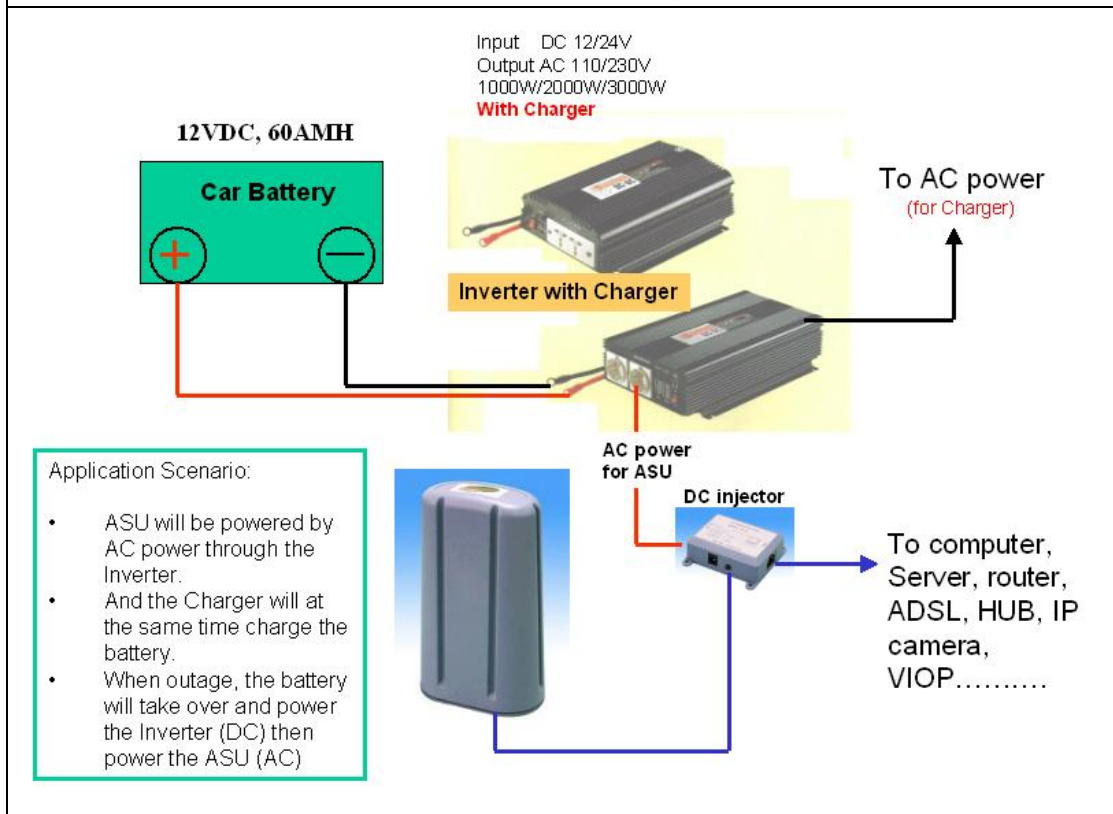













Power back-up with big WATT

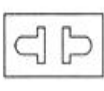
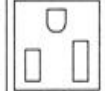

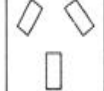
Highlights		<ul style="list-style-type: none"> ● for power supply back-up system – UPS with big power ● Unique soft start ● Automatic fan operation ● Auto-detecting wrong battery ● Output short circuit protection ● Battery low pre-alarm ● Batter low alarm & shut down ● Over load pre-alarm ● Over load alarm and shut down ● Over heat pre-alarm ● Over heat alarm & shut down 				
		●				
		SP-1000C	SP-1500C	SP-2000C	SP-2500C	SP-3000C
Charger for battery		Auto Switch	Auto Switch	Auto Switch	Auto Switch	Auto Switch
Output power (watt)	Continuous	1000	1500	2000	2500	3000
	Surge	2400	3000	3800	4200	5000
Standby current	DC12V	< 0.28A	< 0.5A	<0.9A	<0.6A	<0.8A
	DC24V	< 0.18A	<0.3A	<0.5A	<0.35A	<0.4A
Input Voltage (DC volt)		10V~15V 20V~30V	10V~15V 20V~30V	10V~15V 20V~30V	10V~15V 20V~30V	10V~15V 20V~30V
Output voltage (AC volt)		100~120V 220~240V	100~120V 220~240V	100~120V 220~240V	100~120V 220~240V	100~120V 220~240V
Output waveform		Modified Sine wave	Modified Sine wave	Modified Sine wave	Modified Sine wave	Modified Sine wave
Efficiency		>90%	>85%	>85%	>85%	>85%
Output regulation		+/- 5% Intelligent AVR				
Output Frequency		50/55/60Hz Crystal Controlled				
Low battery protection		<10.5V or 21.5V +/- 0.5V PRE-ALARM <9.5V or 20.5V +/- 0.5V shut-down and alarm				
Over heating protection		>60 C Pre-alarm >65 C Shut-down and alarm			>60C +/- 5C shut-down & alarm	
Overload protection	Pre-alarm	>350W	>650W	>1100W	Shut-down & alarm	Shut-down & alarm
	Shutdown/alarm	>400W	>700W	>1200W		
Battery polarity reverse		By fuse				
Charging capability		NA	Optional			
AC outlet		2 (only 1 if Euro type)			2	
Dimension	mm.	155*73*73	200*173*60	300*196*80	360*169*152	360*169*152
	in.	6.1*2.9*2.9	7.9*6.8*2.4	11.9*7.7*3.1	14.1*6.6*6	14.1*6.6*6
Weight	KG	0.9	2	2.8	6.5	8.5

	LB	1.98	4.4	6.16	14.3	18.7
--	----	------	-----	------	------	------

Approval	      								
Output receptacles	        <table border="1" data-bbox="406 537 1324 593"> <tr> <td>A</td> <td>B</td> <td>C</td> <td>D</td> <td>E</td> <td>F</td> <td>G</td> <td>H</td> </tr> </table>	A	B	C	D	E	F	G	H
A	B	C	D	E	F	G	H		