

BAS70J

SMALL SIGNAL SCHOTTKY DIODE

PINNING

PIN	DESCRIPTION
1	Cathode
2	Anode

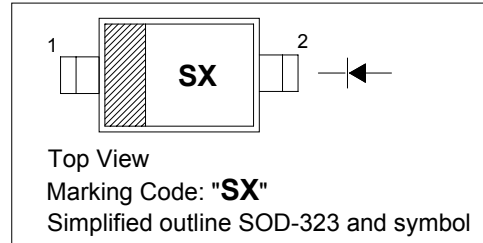

Features

- Very small conduction losses.
- Negligible switching losses.
- Low forward voltage drop.
- Surface mount device.

Absolute Maximum Ratings ($T_j = 25^\circ\text{C}$)

Parameter	Test Conditions	Symbol	Value	Unit
Repetitive Peak Reverse Voltage	-	V_{RRM}	70	V
Continuous Forward Current	-	I_F	70	mA
Surge Non-Repetitive Forward Current	$t_p=10\text{ms}$	I_{FSM}	1	A
Total Power Dissipation	-	P_{tot}	230	mW
Junction Temperature	-	T_J	150	$^\circ\text{C}$
Storage Temperature Range	-	T_s	-65 ... +150	$^\circ\text{C}$
Temperature for Soldering During 10s	-	T_L	260	$^\circ\text{C}$

Maximum Thermal Resistance ($T_j = 25^\circ\text{C}$)

Parameter	Symbol	Value	Unit
Junction to ambient (note1)	$R_{th(j-a)}$	550	$^\circ\text{C/W}$

Note: 1. Mounted on epoxy board , with recommended pad layout.

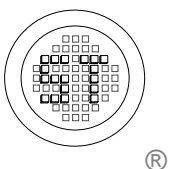

SEMTECH ELECTRONICS LTD.

(Subsidiary of Semtech International Holdings Limited, a company listed on the Hong Kong Stock Exchange, Stock Code: 724)



ISO 14001 Certificate No. 7116
 Dated : 29/10/2004

BAS70J

Characteristics at $T_j = 25^\circ\text{C}$

Parameter	Test Conditions	Symbol	Min	Typ	Max	Unit
Forward Voltage	$I_R = 10\mu\text{A}$	V_{BR}	70	-	-	V
Forward Voltage(Note 1)	$I_F = 1\text{mA}$	V_F	-	-	410	mV
Reverse Current (Note 2)	$V_R = 50\text{V}$	I_R	-	-	100	nA
Diode Capacitance	$V_R = 0\text{V}$, $f = 1\text{MHz}$	C_{tot}	-	-	2	pF
Effective Carrier Life Time	$I_F = 5\text{mA}$	τ	-	-	100	ps

Note: 1. $t_p = 380\mu\text{s}$, $\delta < 2\%$.

2. $t_p = 5\text{ms}$, $\delta < 2\%$.

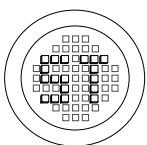

®

SEMTECH ELECTRONICS LTD.

(Subsidiary of Semtech International Holdings Limited, a company listed on the Hong Kong Stock Exchange, Stock Code: 724)



ISO 14001 Certificate No. 7116
Dated : 29/10/2004

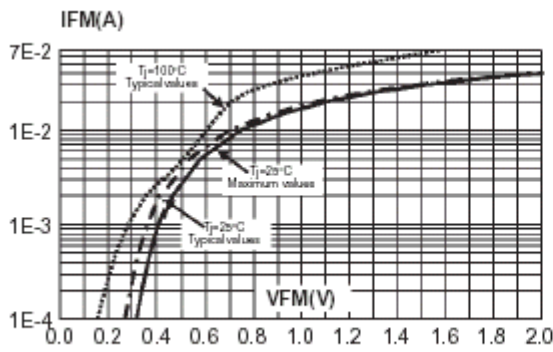

Fig. 3: Reverse leakage current versus junction temperature (typical values).

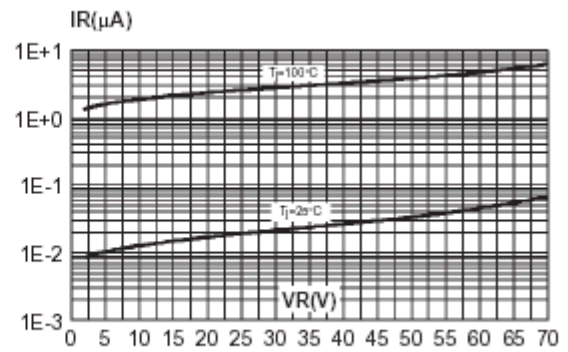
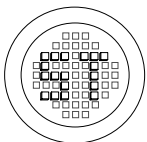
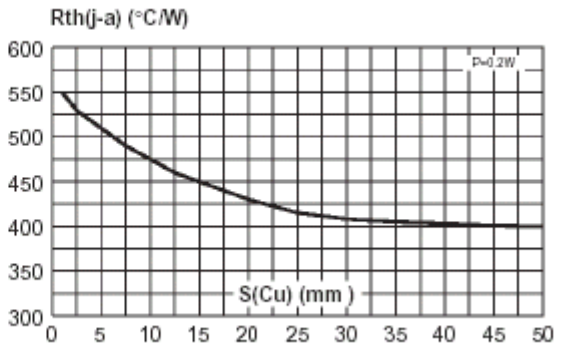
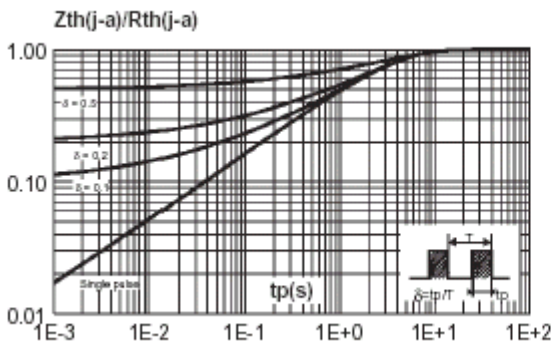
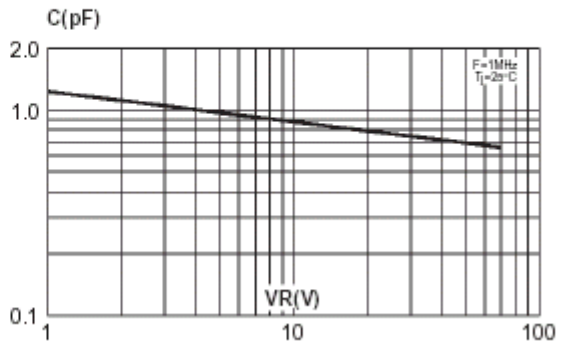
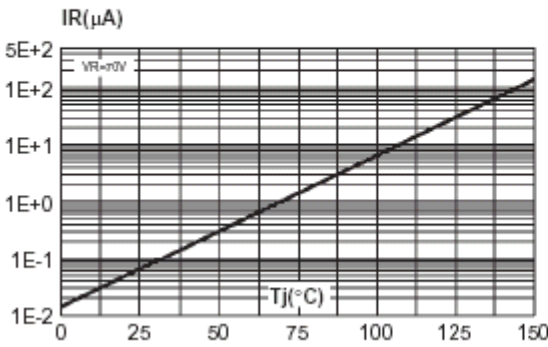

Fig. 4: Junction capacitance versus reverse voltage applied (typical values).



SEMTECH ELECTRONICS LTD.

(Subsidiary of Semtech International Holdings Limited, a company listed on the Hong Kong Stock Exchange, Stock Code: 724)



ISO 14001 Certificate No. 7116
Dated : 29/10/2004

BAS70J

PACKAGE OUTLINE

Plastic surface mounted package; 2 leads

SOD-323

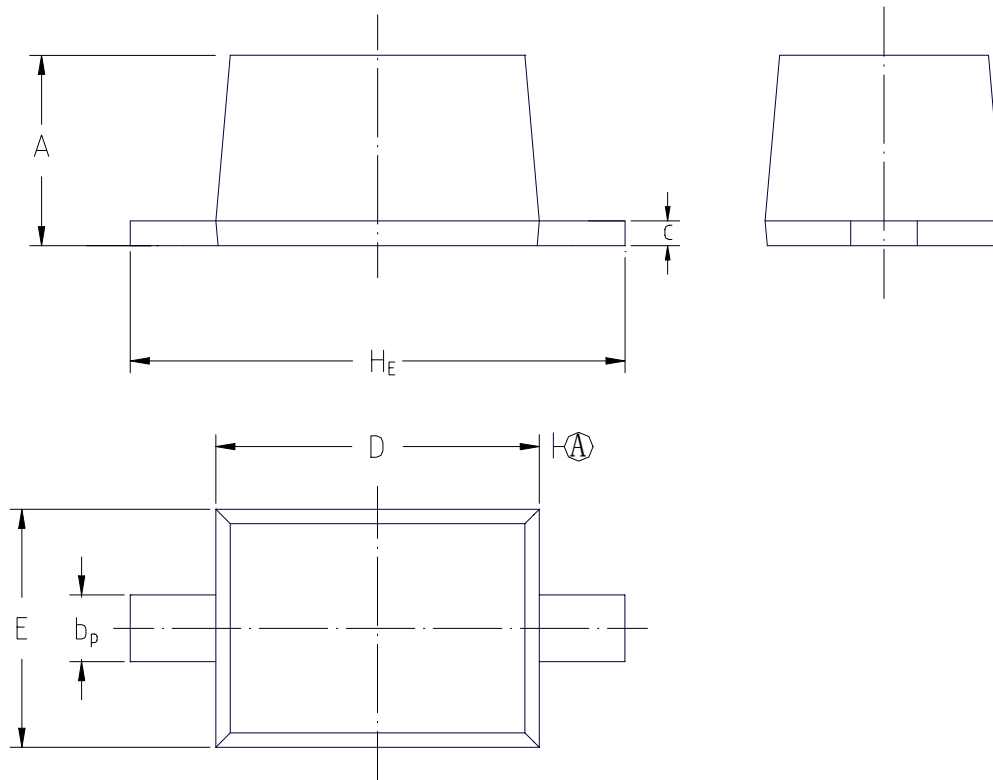

UNIT	A	b_p	c	D	E	H_E
mm	1.10 0.80	0.40 0.25	0.15 0.00	1.80 1.60	1.35 1.15	2.80 2.30

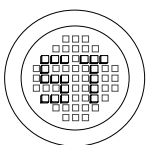

®

SEMTECH ELECTRONICS LTD.

(Subsidiary of Semtech International Holdings Limited, a company listed on the Hong Kong Stock Exchange, Stock Code: 724)



ISO 14001 Certificate No. 7116
Dated : 29/10/2004