



东一部品仕样承认书

APPROVAL SHEET

客 户 CUSTOMER	
客户产品编码/规格 PRODUCT SPECIFICATION	
品 名 PART NAME	轻触开关
型 号 MODEL	TP-1100A
制 样 DSGD BY	叶玉兰
审 核 CHKD BY	富 胜
担 当 APPD BY	富 胜
送 样 日期 SENDING DATE	日期:
承认印 APPD PRINT	

深 圳 市 东 一 部 品 电 子 有 限 公 司

TONES PARTS ELECTRONICS CO.,LTD

ADD: 深圳市龙岗区坪地镇黄竹工业区

HUANGZHU INDUSTRIAL PARK PINGDI TOWN

LONGGANG AREA SHENZHEN CITY CHINA

TEL: 0755-84091585 84090865

FAX: 0755-84090796

HTTP: //www.e-hanxing.com

E-mail:root@e-hanxing.com

NO	DESCRIPTION	MATERIAL	Q'TY	WEIGHT	REMARK
1					
2					

CIRCUIT DIAGRAM

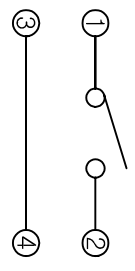

P.C.B DIAGRAM

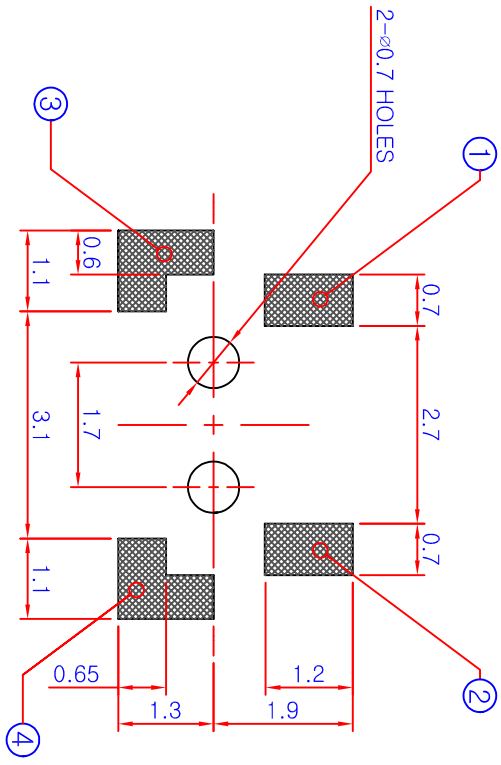

* NOTES

1. RATING : DC 12V , 50mA
2. TRAVEL : 0.2 ± 0.1mm
3. OPERATING FORCE : 160 ± 50gf
4. CONTACT RESISTANCE : 100mΩ MAX
5. LIFE : 100,000 CYCLES Min

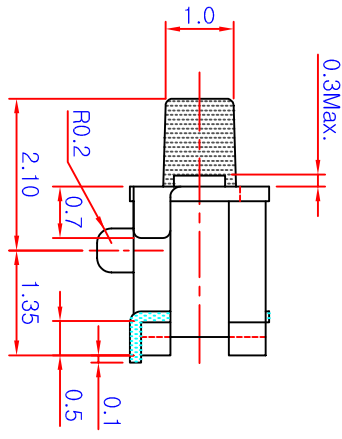
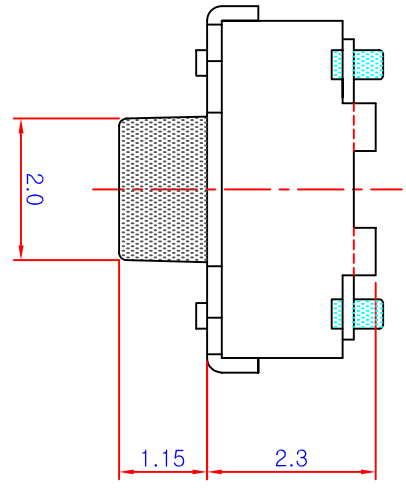
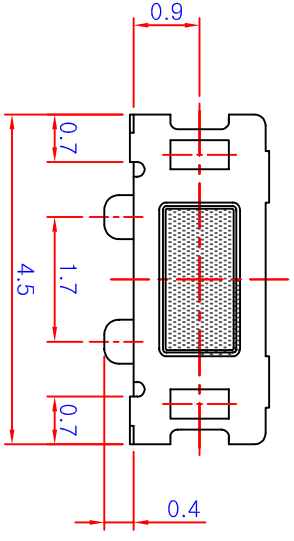
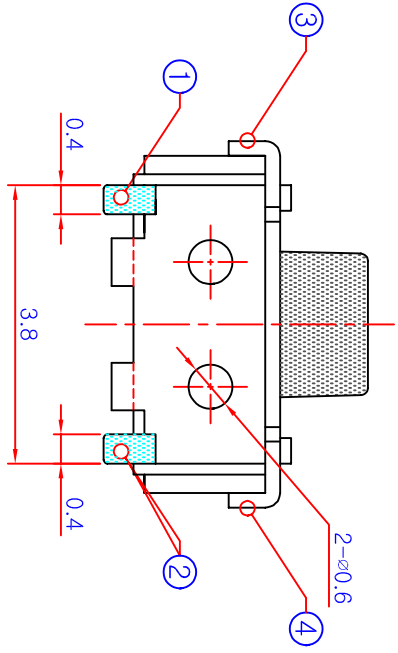

NAME _____ REVDATE _____ FRAME _____

MARK	REVISION	DESCRIPTION	DATA	NAME	REMARK
△					
△					

GENERAL TOLERANCE			
	1	2	3
0 - 4	±0.05	±0.1	±0.2
4 - 16	±0.08	±0.15	±0.3
16 - 64	±0.12	±0.25	±0.5
64 - 250	±0.25	±0.4	±0.8

UNIT	SCALE
mm	10/1
PAPER	297 X 210 A4
PAGE	1-1

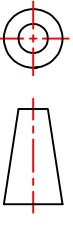

MODEL NAME : **TP-1100A**

TITEL : TACT S/W ASS'Y

TONER PARTS



kyf

DRAWING NUMBER :

DATE : 2005 년 03 월 15일

4

5

6

	SPECIFICATION LIST	
	TACT SWITCH	SAMPLE : 1 EA

1 General

- 1.1 Switch rating DC 12v, 50mA
- 1.2 Operating temperature -30°C - 80°C
- 1.3 Preservative temperature range -40°C - 90°C
- 1.4 Appeal and dimensions See outside drawing page
- 1.5 Standard Conditions Unless otherwise specification ,the test and measurements shall be carried out as follows
- Ambient temperature :5-35°C
- Relative humidity :45-85%
- Air pressure :86-106Kpa (860-1060mbar)
- However if doubt arises on the decision based on measured values under the above-mentioned conditions, the following shall be employed.
- Ambient temperature :20±3°C
- Air pressure :86-106Kpa (860-1060mbar)

2. Performance

2.1 Electrical characteristics

	Items	Test Conditions	Criteria
2.1.1	Contact resistance	Applying a static load twice the actuating force to the center of the stem ,measurements shall be made with a 1KHZ small-current contact resistance meter.	100mΩ MAX
2.1.2	Insulation resistance	Measurements shall be made following application of DC 100V potential across terminals and frame for one minute.	100MΩ MIX
2.1.3	Dielectric withstand in voltage	AC 250V(50HZ or 60HZ) shall be applied across terminals and frame for one minute.	There shall be no breakdown

						APPD	CHKD	DSGD	TITLE
						Fusheng	Yun	Qiang	TACT SWITCH
							Zhang	Li	DOCUMENT NO.
ZONE	SYMB	DATE	APPD	CHKD	DSGD				

		SPECIFICATION LIST		
		TACT SWITCH		SAMPLE: 2 EA

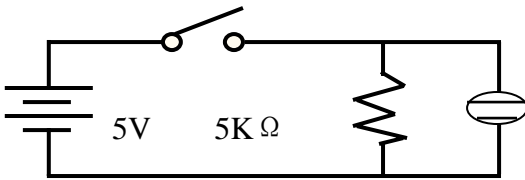
Items	Test Conditions	Criteria
2.1.4 Bounce	Lightly striking the center of the stem a rate encountered in normal use(3 to 4 operations parsec)bounce shall be tested at "ON" and "OF" Switch 	

2.2 Mechanical characteristics

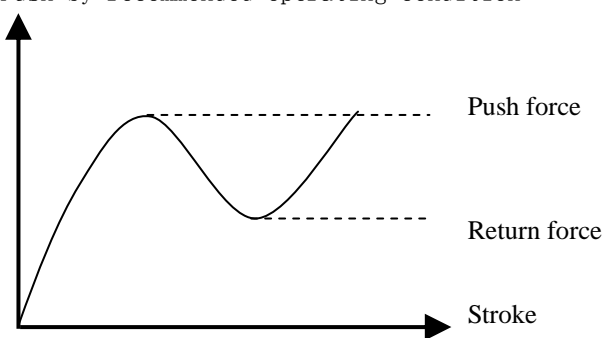
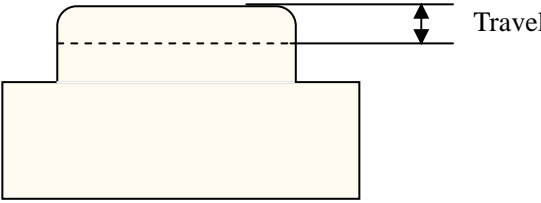
Items	Test Conditions	Criteria
2.2.1 Operating force	Push by recommended operating condition 	Refer to individual product drawing.
2.2.2 Travel	Push by recommended operating condition $F = (\text{Operation force}) \times 2$ 	Refer to individual product drawing.
2.2.3 Stop strength	A static load of 3Kgf shall be applied in the direction of stem operation for a period of 60 Seconds	No damage(Electrical and mechanical)

						APPD Fusheng	CHKD Yun Zhang	DSGD Qiang Li	TITLE TACT SWITCH
									DOCUMENT NO.
ZONE	SYMB	DATE	APPD	CHKD	DSGD				

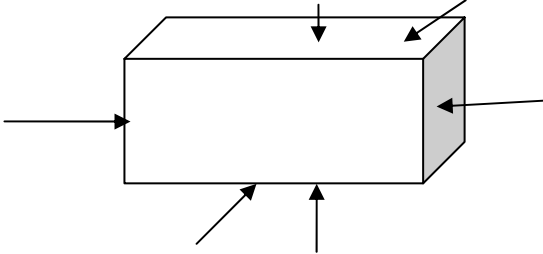
		INSPECTION LIST		
		TACT SWITCH	SAMPLE:	3 EA
	Items	Test Conditions	Criteria	
2.2.4	Vibration test	(1) Amplitude :1.5mm (2) Sweep rate: 10-55-10HZ for1 minute (3) Sweep method: Logarithmic frequency sweep rate (4) Vibration direction :X .Y.Z(3 directions) (5) Time :Each direction 2hours(Total 6hours)	No 2.1 and 2.2.1 to2.2.2 shall be satisfied	
2.2.5	Impact shock test	(1) Acceleration: 80G (2) Cycle of test:3cycle each in 6 directions for a total 18 cycle. 	NO 2.1 and 2.2.2 shall be satisfied	
2.2.6	managerial Soldering Conditions	Soldering area:t/2 of P.W.B thickness (P.W.B :t=1.6) Soldering temperature: 260±5℃ Soldering time :5±1 sec	No damage(Electrical and mechanical)	

2.3 Climatic characteristics

	Items	Test Conditions	Criteria	
2.3.1	Cold test	(1) Temperature : -30℃ ±2℃ (2) Duration of test :96 hours (3) Take off a drop water (4) Standard condition after test :1 hour	Contact resistance: 200mΩ max NO2.1.2 to2.1.4 and 2.2.1to 2.2.2 shall be satisfied	
2.3.2	Heat test	(1) Temperature:80±2℃ (2)Duration of test :96 hours (3)Standard condition after test :1 hour	Contact resistance 200m Ω max NO2.1.2 to2.1.4 and 2.2.1to 2.2.2 shall be satisfied	
2.3.3	Temperature cycle	(1) Test cycled:5 cycles (2) Standard conditions after test: 1 hours (3) 1 cycle	Contact resistance 200m Ω max NO2.1.2 to2.1.4 and 2.2.1to 2.2.2 shall be satisfied	

						APPD Fusheng	CHKD Yun Zhang	DSGD Qiang Li	TITLE TACT SWITCH
									DOCUMENT NO.
ZONE	SYMB	DATE	CHKD	CHKD	DSGD				

		INSPECTION LIST			
		TACT SWITCH		SAMPLE: 4 EA	

Items	Test Conditions	Criteria
2.3.4	Humidity (1) Temperature: $60 \pm 2^{\circ}\text{C}$ (2) Relative humidity :90-95% (3) Duration of test :96 hours (4) Take off a drop water (5) Standard conditions after test :1 hours	Contact resistance $200\text{m}\Omega$ max N02.1.2 to2.1.4 and 2.2.1to 2.2.2 shall be satisfied
2.3.5	Operating life test (1)DC 5V,5mA resistance load (2)Operation speed: 1 cycled/sec (3)Push force :maximum value of operation force (4)Cycle of operation :Refer to individual product drawing	Contact resistance $200\text{m}\Omega$ max Bounce:20m sec max Actuating force: \pm 30% intial force No 2.1.2 to 2.1.3 and 2.2.2 shall be satisfied
2.3.6	Withstand HS (1) Denslty: 3 ± 1 PPM (2) Temperature : $40 \pm 2^{\circ}\text{C}$ (3) Relative humidity :90-95% (4) Duration of test :24 hours (5) Standard conditions after test :1 hours	Contact resistance $200\text{m}\Omega$ max N02.1.2 to2.1.4 and 2.2.1to 2.2.2 shall be satisfied
2.3.7	Withstand SO ₂ (6) Denslty: 10 ± 2 PPM (7) Temperature : $40 \pm 2^{\circ}\text{C}$ (8) Relative humidity :90-95% (9) Duration of test :24 hours Standard conditions after test :1 hours	Contact resistance $200\text{m}\Omega$ max N02.1.2 to2.1.4 and 2.2.1to 2.2.2 shall be satisfied

						APPD Fusheng	CHKD Yun Zhang	DSGD Qiang Li	TITLE TACT SWITCH
									DOCUMENT NO.
ZONE	SYMB	DATE	CHKD	CHKD	DSGD				

3. Reflow soldering

Please practice according to below conditions

- 1) Thickness of printed circuit board shall be 1.6mm
- 2) Switch terminal and PCB upper face shall be free from flux prior to soldering.
- 3) Safeguard the switch assembly against flux penetration from its top side.

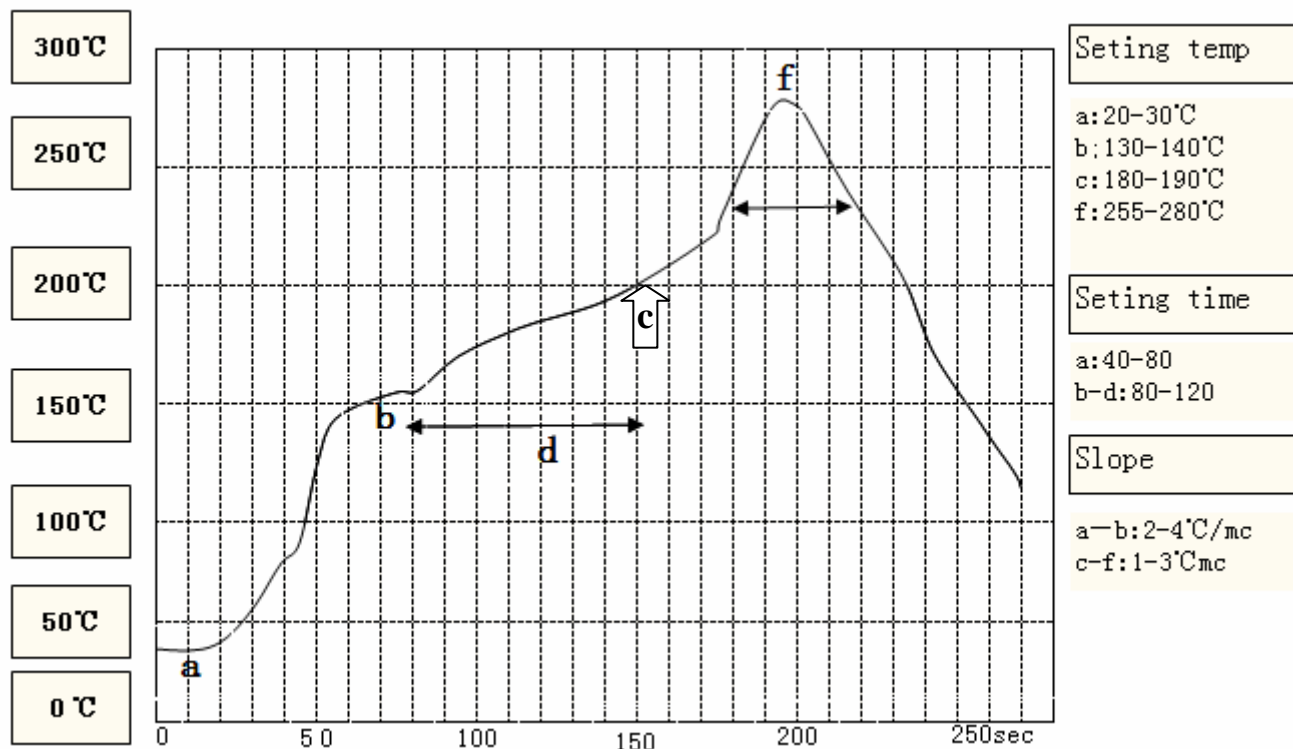

						APPD Fusheng	CHKD Yun Zhang	DSGD Qiang Li	TITLE TACT SWITCH
									DOCUMENT NO.
ZONE	SYMB	DATE	CHKD	CHKD	DSGD				