

RoHS Compliant

REV	ZONE	LTR	DESCRIPTION	DATE	REVISER	APPD
-----	------	-----	-------------	------	---------	------

A
B
C
D
E
F

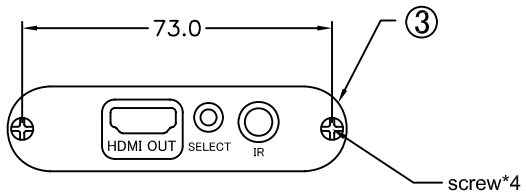
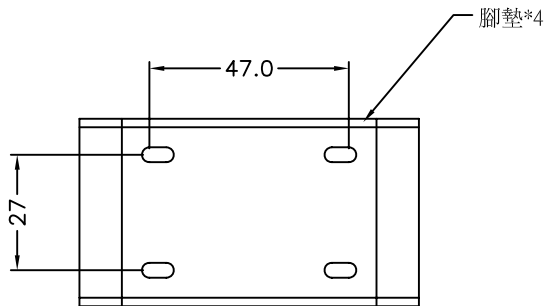
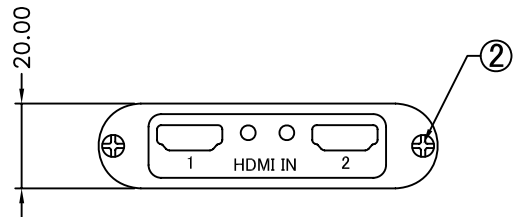
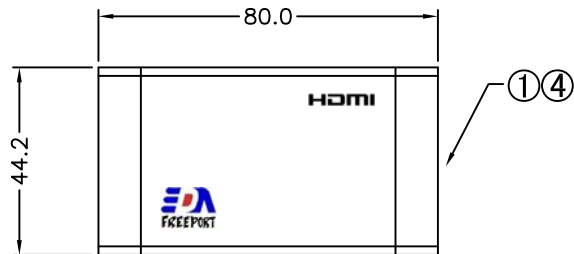

A VIEW

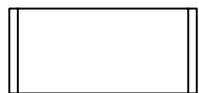

← A VIEW

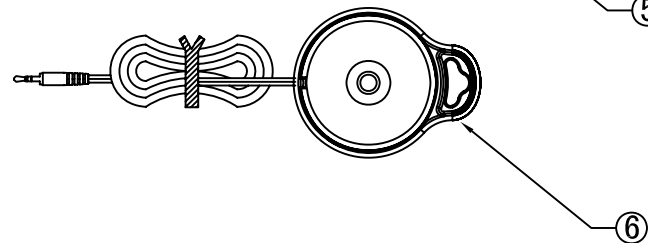
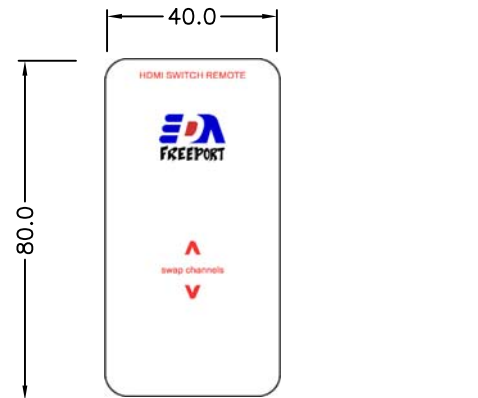

6	IR RECIEVER	IR RECIEVER	1PCS
5	IR REMOTE	IR REMOTE CONTROLER(80*40*5)	1PCS
4	PCB ASSEMBLY	FRONT PANEL	1PCS
3	BACK SHEET	PCB ASSEMBLY	1PCS
2	FRONT SHEET	BOTTOM SHELL	1PCS
1	MAIN SHELL	TOP SHELL	1PCS

NO.	PART NAME	SPEC DESCRIPTION	REMAKE
MATERIAL		TOLERANCE UNSPECIFIED	
		± 0.25	
		± 0.50	
FINISH		ANGLE ± 1°	SCALE NONE
		UNIT mm	
DRAWN WRZ Nov16,06		NAME	SHEET 1/2
DESIGNER WRZ Nov16,06		HDMI 2X1 SWITCHER	
CHECKED		DRAWING NO.	R-S1HS-23
APPROVED		REV	

RoHS Compliant

REV	ZONE	LTR	DESCRIPTION	DATE	REVISER	APPD
-----	------	-----	-------------	------	---------	------





ORDERING INFORMATION:

HS * * - * * * - *
 (1) (2) (3) (4) (5) (6) (7)

- (1) SERIES NUMBER:
HS : HDMI SWITCHER
- (2) INPUT PORT QUANTITY
2 : 2 INPUT PORT
- (3) OUTPUT PORT QUANTITY
1 : 1 OUTPUT PORT
- (4) COLOR NO :
0: SILVER
- (5) SILKPRINT COLOR NO. :
4: RED COLOR IN WHITE LETTER
- (6) CUSTOMER LOGO :
A:WITH "FREEPORT" LOGO
- (7) SUFFIX NO :
1: WITH REMITTER AND REMOTE CONTROLLER

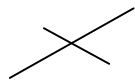
Technical Details:

- 1. Easy switching of multiple HDMI sources by using remote control or the switch button on the switcher.
- 2. Frequency Bandwidth: 1.65 Gbps
- 3. Individual LED Display of video source channels.
- 4. Maintains highest HDMI single link video resolution: Supports HDTV resolution of 480p, 720p, 1080i and 1080p & Supports VGA, SVGA, SXGA(1280x1024), UXGA(1600x1200) and 1920x1200.
- 5. Supports DDWG standard for HDMI compliant monitors.
- 6. Inputs: Two Type A 19-pin HDMI female ports
- 7. Output: One Type A 19-pin HDMI female port

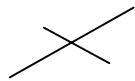
MATERIAL 	TOLERANCE UNSPECIFIED ± ± ± ± ± ±	 FREEPORT	
	ANGLE ± ±	  SCALE NONE	UNIT mm
FINISH 	DRAWN WRZ Nov16,06	NAME	
	DESIGNER WRZ Nov16,06	HDMI 2X1 SWITCHER	
	CHECKED	DRAWING NO. R-S1HS-23	
	APPROVED	REV 0.1	
		A4	RS1HS231