

2.54mm FPC Connector

SPECIFICATIONS

Current Rating: 1.0AMP
 Contact Resistance: 30m Ω Max. FILE NO.E248993
 Insulation Resistance: 1000M Ω Min.
 Withstanding Voltage : 200V AC/Minute
 Operation Temperature: -40°C to +80°C
 Contact Material: Phosphor Bronze
 Contact plating: Tin Plated
 Insulator Material: Polyester (UL94V-0)
 StandArd: PBT+30%GF

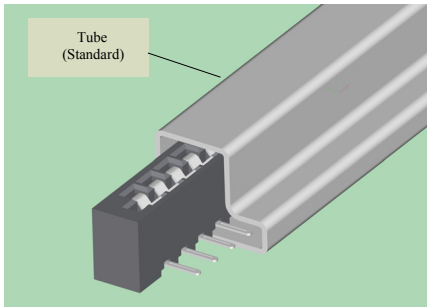

5110-XXSDDNX01

5110-XXRDDNX01

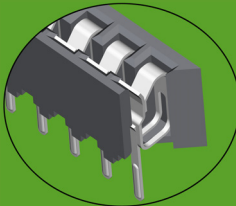

SECTION

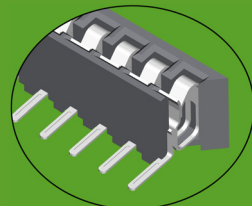

SECTION

5110- XX X D D N X 01

NO.OF PINS
 PER ROW
 03~30P

CONTACT SHARP
 S: Straight Angle
 R: Right Angle

INSULATOR COLOUR
 B: Black W: White
 E: Beige A: Brown

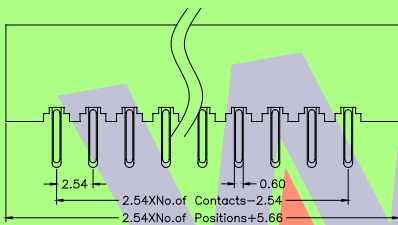
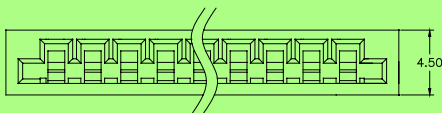

Recommended P. C. B Layout (Top Side)

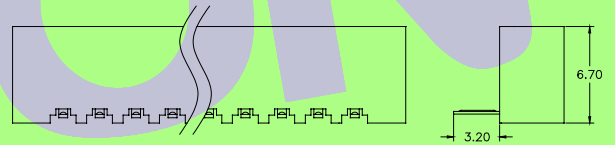
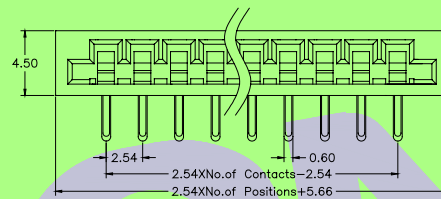

Recommended P. C. B Layout (Top Side)

※INNOVATION AND DEVELOPMENT※CONTINUAL IMPROVEMENT※QUALITY FOREMOST※CUSTOMER SATISFACTION※

Http:www.wafe-china.com E-mail:sales@wafe-china.com

WAFE DONGGUAN FAX:+86 769 85358915 TEL:+86 769 85358920
 WAFE KUNSHAN FAX:+86 512 57468468 TEL:+86 512 57468418