

Specifications

Nominal voltage		1.2V	
Capacity (mAh)		0.2C	1C
	Nominal	2000	1800
	Typical	2100	2000
Diameter		0.89±0.02 in 22.5±0.5 mm	
Height		1.67±0.02 in 42.5±0.5 mm	
Weight		62g(2.187oz.)	
Internal impedance at 1000Hz.		12mΩ (After charge)	
Charge	Standard		200mA×15hrs.
	Quick		2000mA×1.2hrs.
	Trickle	Max.	100mA
		Min.	66mA
Ambient temperature	Charge	Standard	-10°C~50°C 14°F~122°F
		Quick	0°C~45°C 32°F~113°F
	Discharge		-20°C~65°C -4°F~149°F
	Storage		-20°C~45°C -4°F~113°F

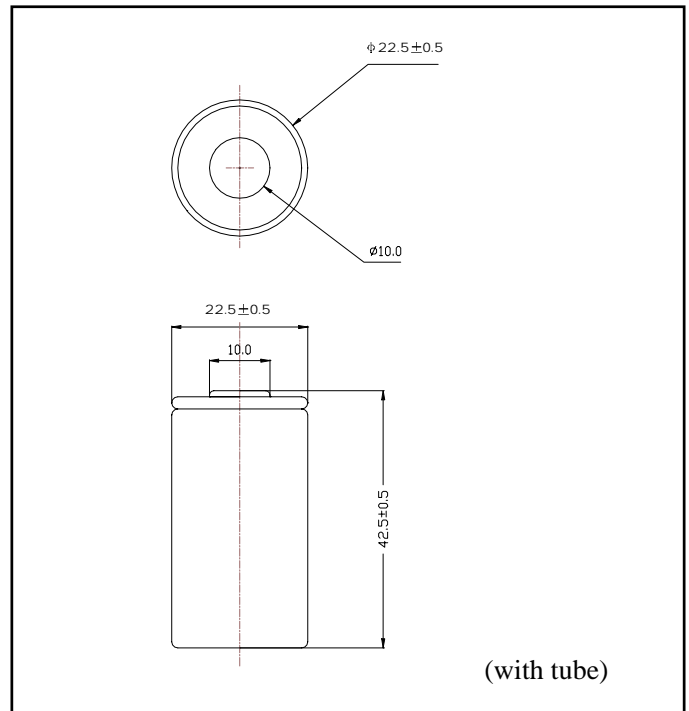

Note:

1. Nominal capacity, rated at 0.2C,20°C.
2. Other capacities are for reference.
3. Weight and internal impedance are for reference.

