

**RoHS Compliant**

REV	ZONE	LTR	DESCRIPTION	DATE	REVISER	APPD
-----	------	-----	-------------	------	---------	------

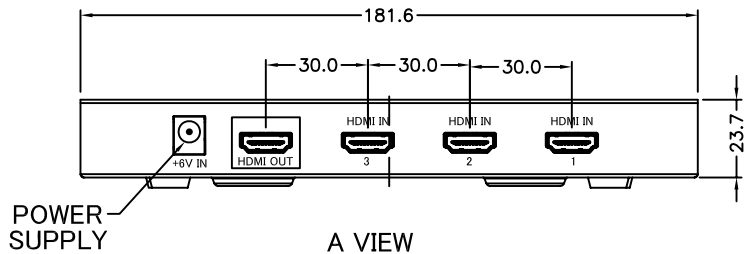
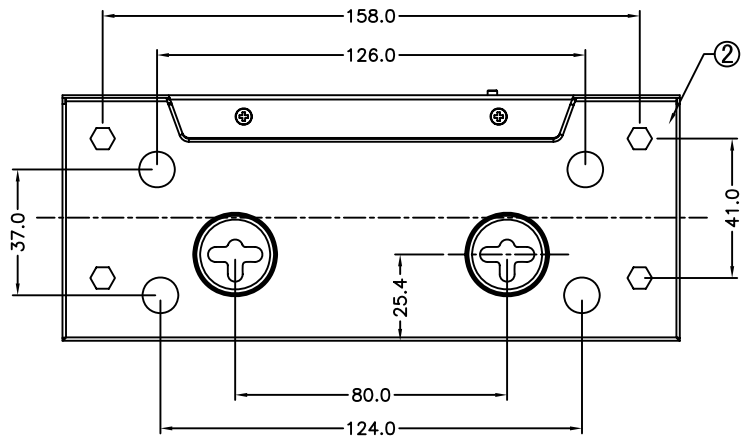
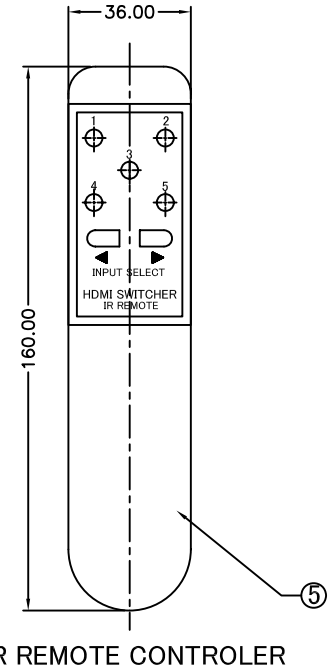
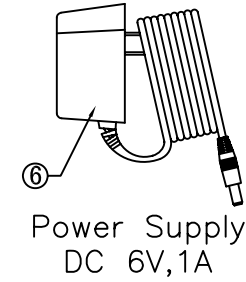
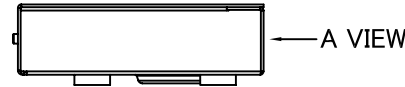
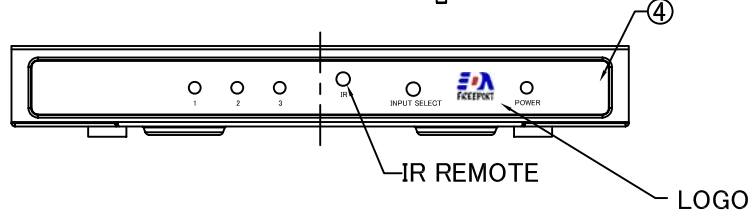
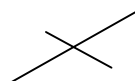
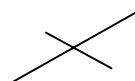
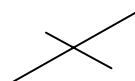

NO.	PART NAME	SPEC DESCRIPTION	REMAKE
6	POWER SUPPLY	POWER SUPPLY	1PCS
5	IR REMOTE	IR REMOTE (160*36*16)	1PCS
4	FRONT PANEL	FRONT PANEL	1PCS
3	PCB ASSEMBLY	PCB ASSEMBLY	1PCS
2	BOTTOM SHELL	BOTTOM SHELL	1PCS
1	TOP SHELL	TOP SHELL	1PCS

NO.	PART NAME	SPEC DESCRIPTION	REMAKE
MATERIAL		TOLERANCE UNSPECIFIED	
		±	
		± 0.25	
		± 0.50	
		± 1*	
FINISH		ANGLE	
		DRAWN	WRZ Aug24,06
		DESIGNER	WRZ Aug24,06
		CHECKED	
		APPROVED	
		SCALE	NONE
		UNIT	mm
		NAME	HDMI 3X1 SWITCHER
		DRAWING NO.	R-S1HS-2
		SHEET	1/2
		REV	1

ORDERING INFORMATION:

HS   \*   \*   -   \*   \*   \*   -   \*  
 (1) (2) (3) (4) (5) (6) (7)

- (1) SERIES NUMBER:  
HS : HDMI SWITCHER
- (2) INPUT PORT QUANTITY  
3 : 3 INPUT PORT
- (3) OUTPUT PORT QUANTITY  
1 : 1 OUTPUT PORT
- (4) COLOR NO. :  
1:BLUE 2:GRAY 3:BLACK
- (5) FRONT PANEL :  
1:BLACK COLOR IN WHITE LETTER  
2:SILVER WHITE COLOR IN BLACK LETTER
- (6) SUFFIX NO. :  
A:WITH "FREEPORT" LOGO
- (7) POWER SUPPLY TYPE :  
AU:AUSTRALIA TYPE,WITH SAA CERTIFICATE  
UL:USA TYPE,WITH UL CERTIFICATE  
CE:EUROPE TYPE,WITH CE CERTIFICATE  
BS:HK&UK TYPE,WITH BS/CE CERTIFICATE  
JA:JAPAN TYPE,WITH PSE CERTIFICATE

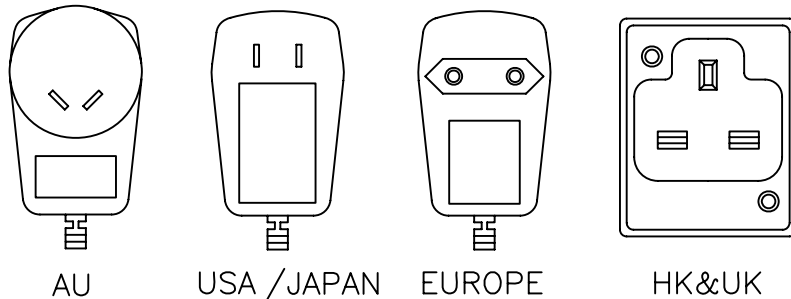

Technical Details:

1. Easy switching of multiple HDMI sources by using remote control or the switch button on the switcher.
2. Frequency Bandwidth: 1.65 Gbps
3. Individual LED Display of video source channels.
4. Maintains highest HDMI single link video resolution: Supports HDTV resolution of 480p, 720p, 1080i and 1080p & Supports VGA, SVGA, SXGA(1280x1024), UXGA(1600x1200) and 1920x1200.
5. Supports DDWG standard for HDMI compliant monitors.
6. Inputs: Three Type A 19-pin HDMI female ports
7. Output: One Type A 19-pin HDMI female port
8. Power supply: DC 6V,1A Adaptor Included
9. Plug-and-play. No software installation required.
10. Supports long length cable application.

MATERIAL	TOLERANCE UNSPECIFIED		
	ANGLE	SCALE NONE	UNIT mm
FINISH	DRAWN WRZ Aug24,06	NAME	
	DESIGNER WRZ Aug24,06	HDMI 3X1 SWITCHER	
	CHECKED	DRAWING NO. R-S1HS-2	
APPROVED	REV 1		SHEET 2/2